

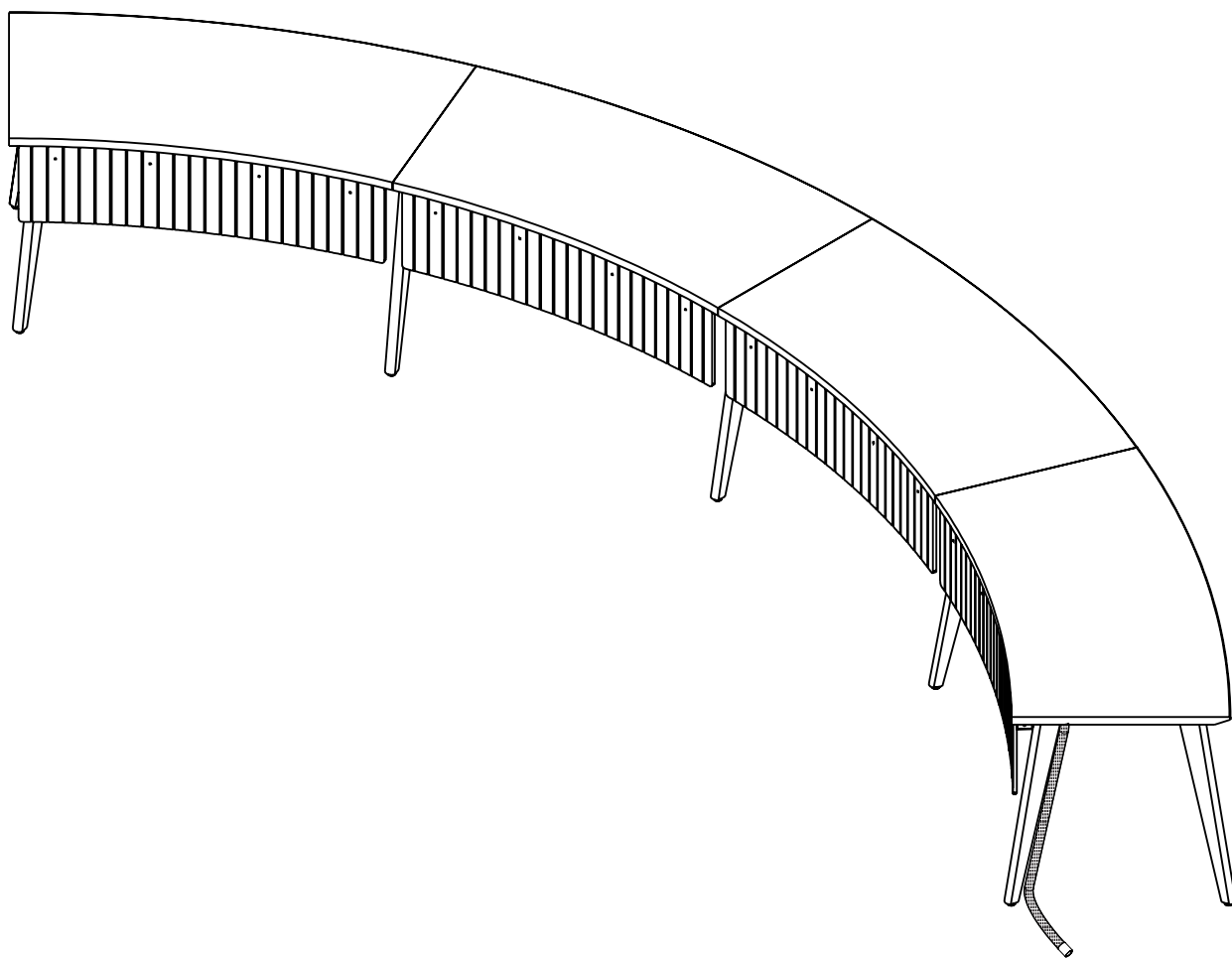

# 18' Arc™ Meeting Table (8 Person)

AT/8P/G2



# PARTS

ID	QTY	PART NUMBER	DESCRIPTION
	(4)	205-6030	ARC Table Top Segment
A	(16)	302-355	8-32 x 1/2" Modesty Panel Fastener
B	(16)	300-485	1/4-20 x 1/2" Cable Raceway Mounting Screw
C	(60)	300-585	1/4-20 x 3/4" Leg Mounting Screw
D	(2)	P-305-590/BO/CM	Table Leg with Wireloom
E	(8)	P-305-590	Table Leg
F	(8)	305-585	Cable Raceway
G	(3)	204-300	Cable Raceway Bridge
H	(4)	204-320	Modesty Panel

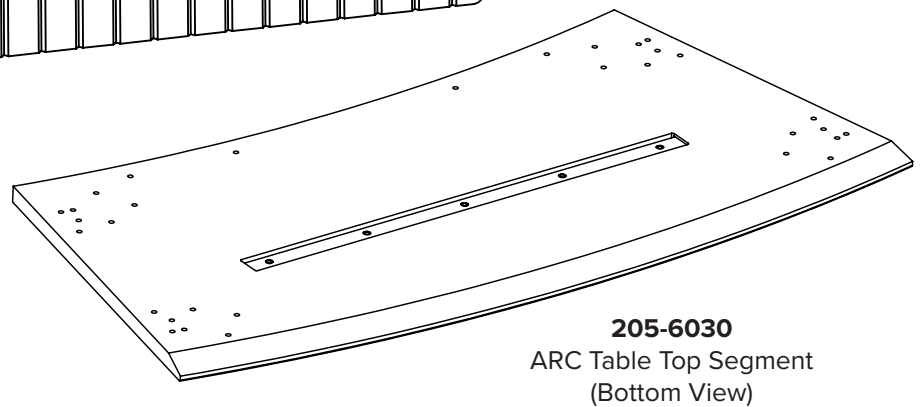
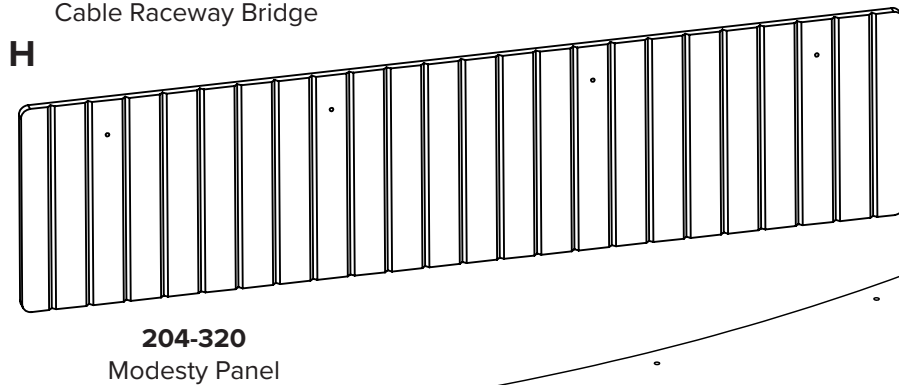
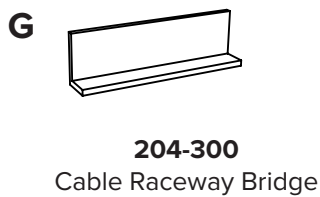
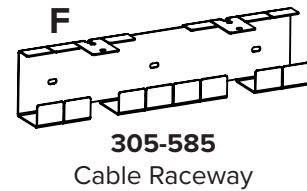
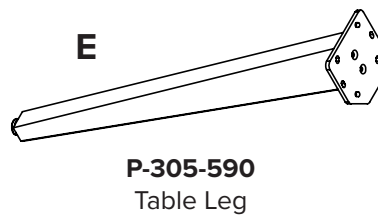
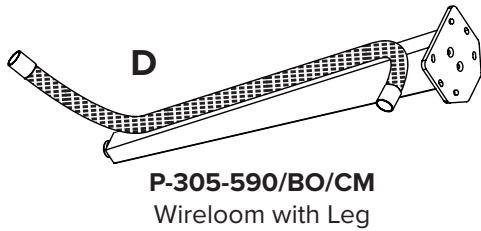
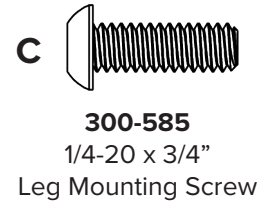
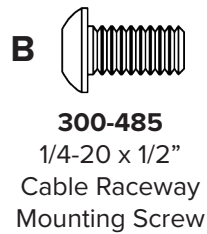
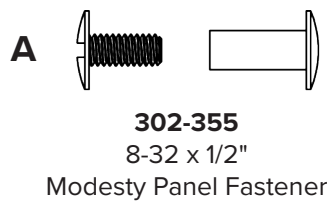

## BEFORE YOU BEGIN

Table will be assembled starting with the left (seated) segment.

### WIRELOOM

Place table leg **(D)** with pre-installed wireloom at desired location. Typically installed in the back side of the table towards the center for wire management to the floor.

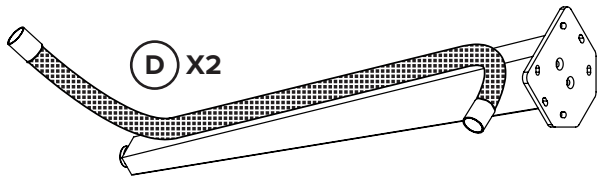

### ACCESSORIES

If your tops have cut-in accessories such as a cable port or charger be sure to select the tops in the order intended from left to right seated position.

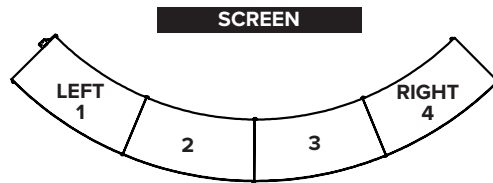

## 1. Modesty Panel

Attach 2 cable raceway brackets **(E)** to non-grooved side of each modesty panel **(H)**. Insert **(A2)** through modesty panel and fasten bracket in place with **(A1)**.

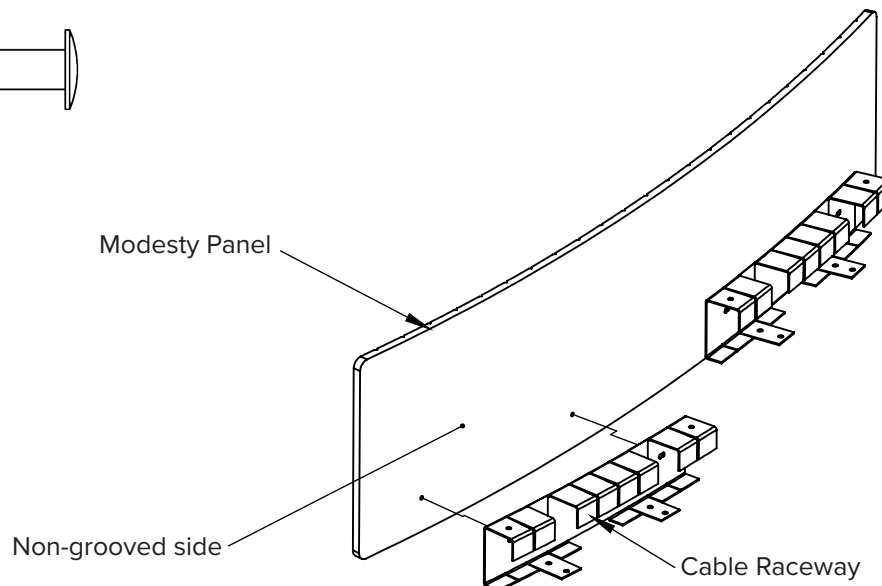

## 2. Table Segment #1

### A. Attach Legs

Use (6) **C** screws to attach the two legs to the mating edge of top.  
Use (8) **C** screws to attach the two outer legs to the top.

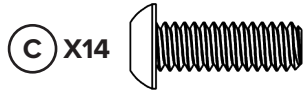

### B. Acoustic Panel

Attach the acoustic modesty panel to the table top using **B** screws.

**Note:** Some flexing of the metal cable raceway may be required to align the mounting holes (closer to the bend) with the table inserts.

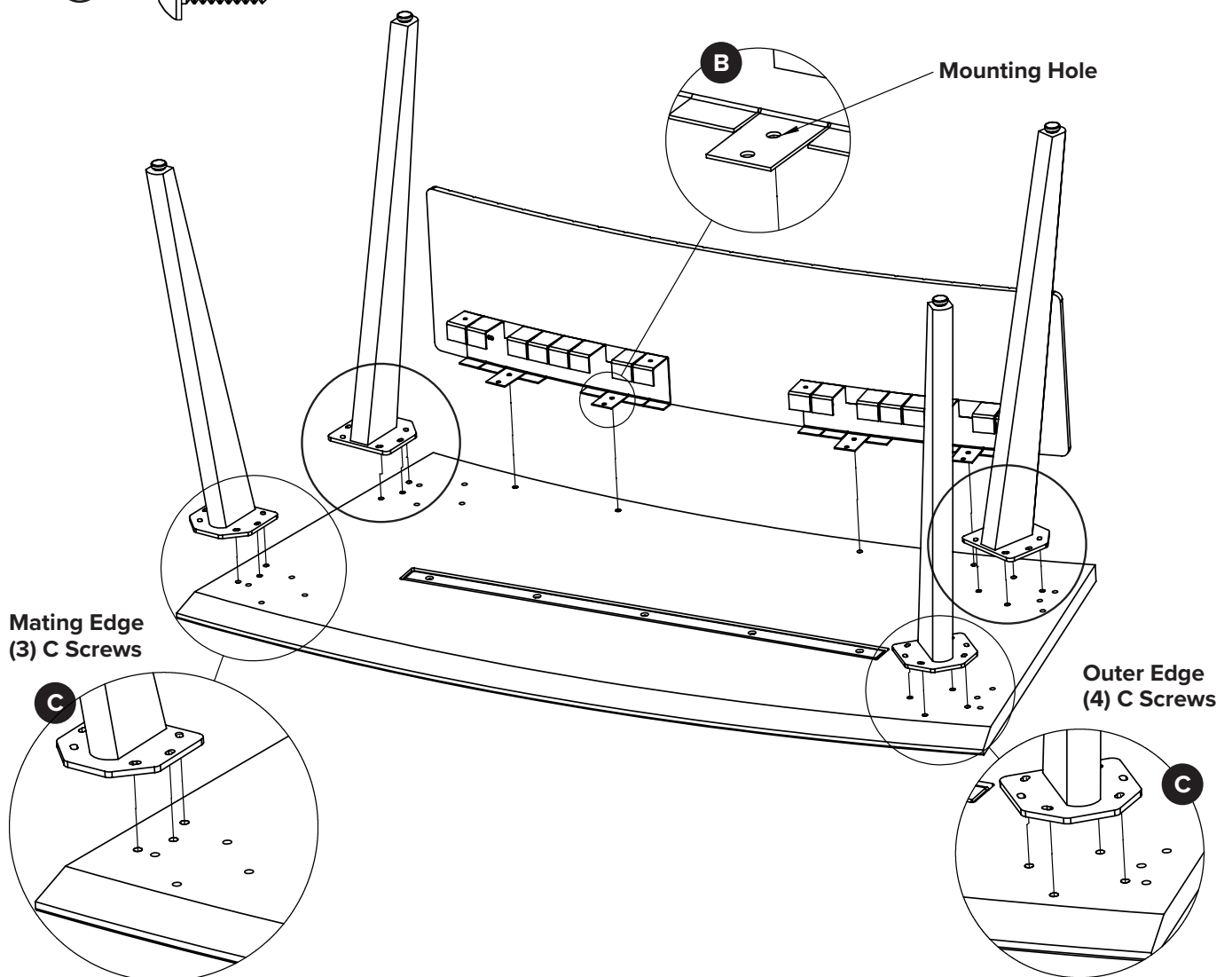

### 3. Table Segments #2 & 3

#### A. Attach Legs

Use (3) C screws per leg.

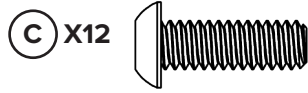

#### B. Acoustic Panel

Use (1) B screws per bracket.

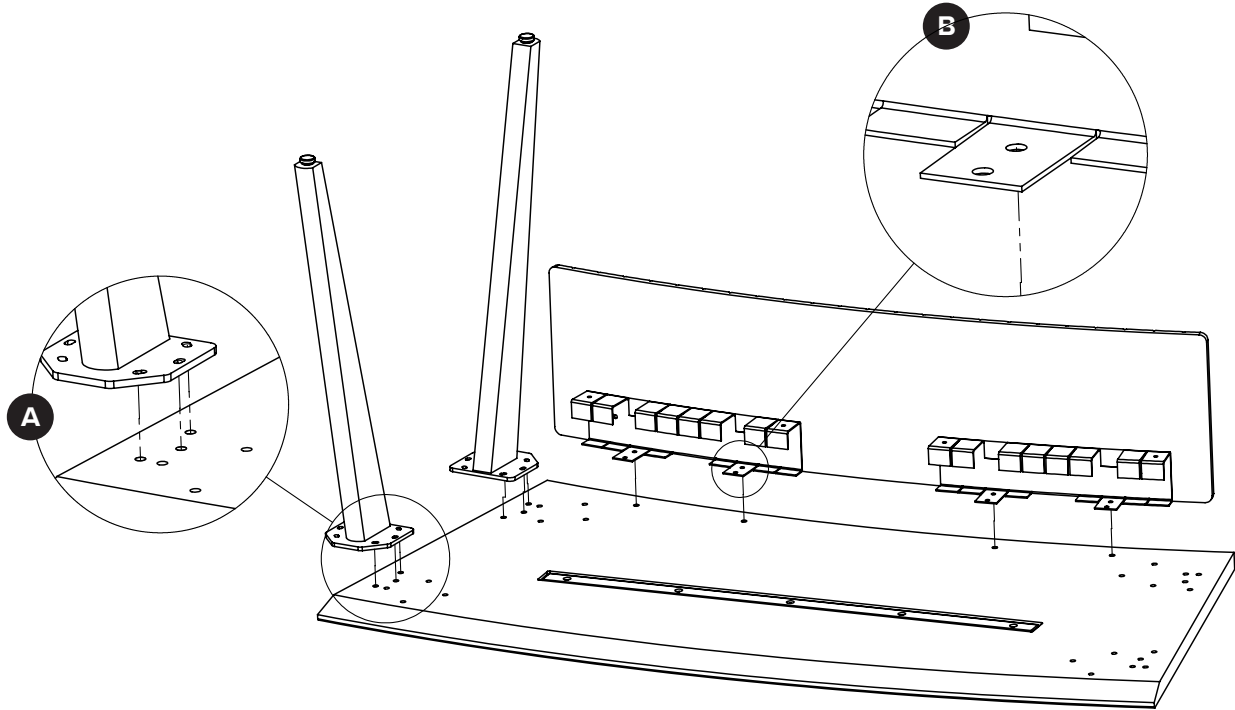

#### C. Join Table Segments

Flip the table segment 2 and position it over the mounting plates of the standing table leg.

Attach (3) C screws to each leg from underneath the table, connecting the two table segments.

If needed, slightly loosen the bolts on the mating legs to ensure proper hole alignment and a snug fit.

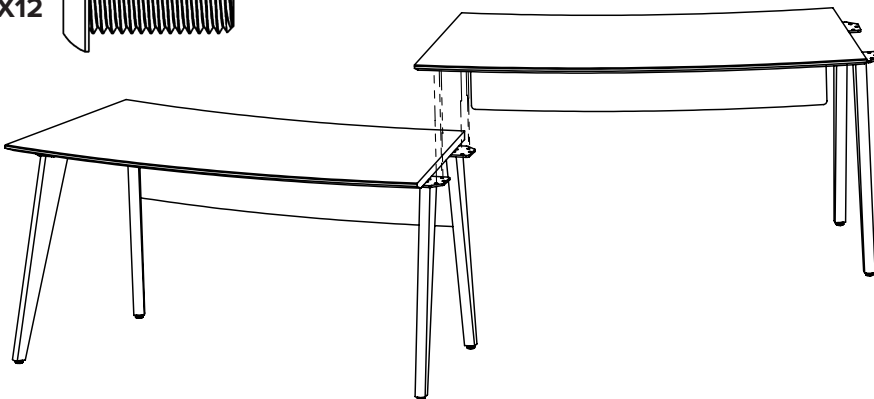
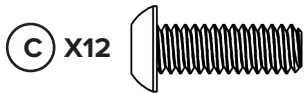

## 4. Table Segment #4

### A. Attach Legs

Use (3) C screws per leg.

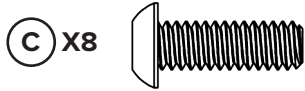

### B. Acoustic Panel

Use (1) B screws per bracket.

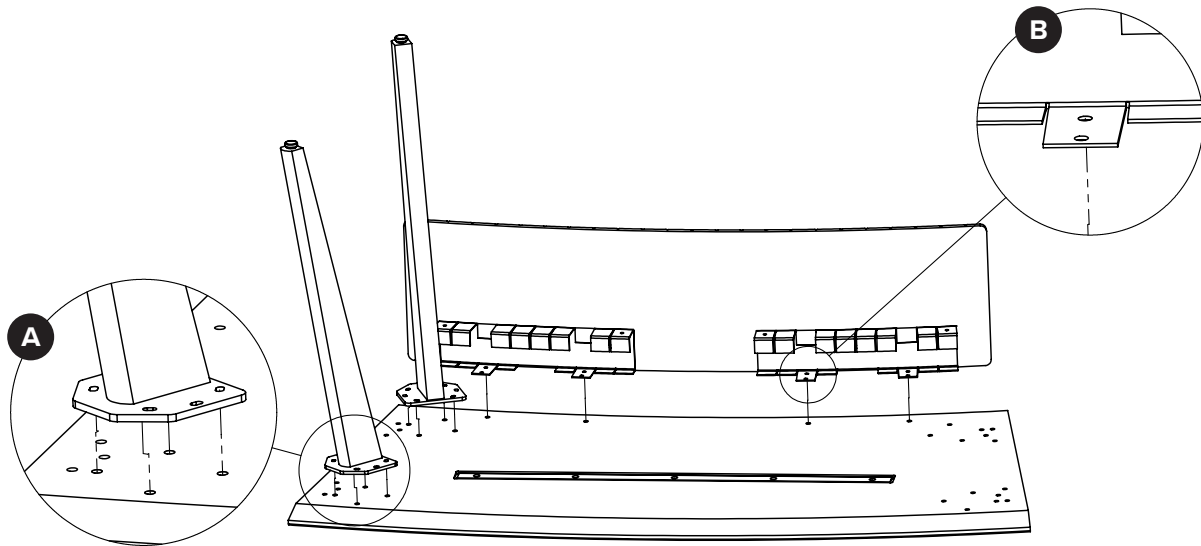

### C. Join Table Segments

Flip the table segment 3 and position it over the mounting plates of the standing table leg.

Attach (3) C screws to each leg from underneath the table, connecting the two table segments.

If needed, slightly loosen the bolts on the mating legs to ensure proper hole alignment and a snug fit.

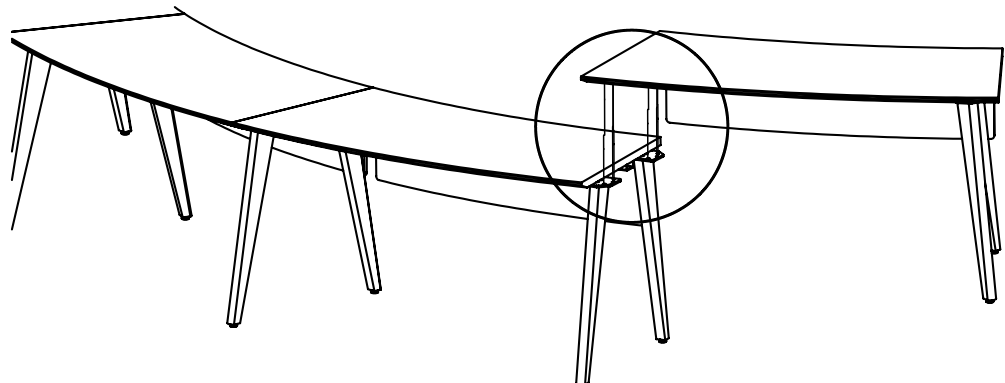
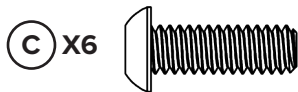

## 5. Level Table

Position table in the desired location and level if needed using the threaded leveling feet.



**CAUTION:** When relocating the assembled table, exercise caution and ensure that each section is adequately supported during the move.

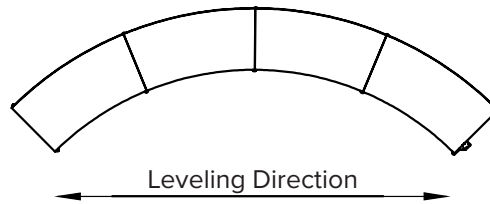
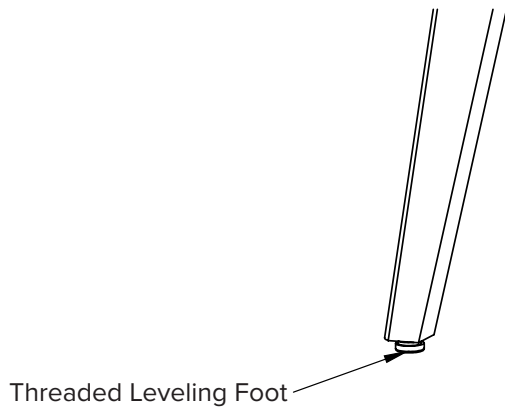

## 6. Install Cable Bridge

Insert cable bridge by sliding it in from the side of the cable raceway, towards the gap between the modesty panel and the table segments.

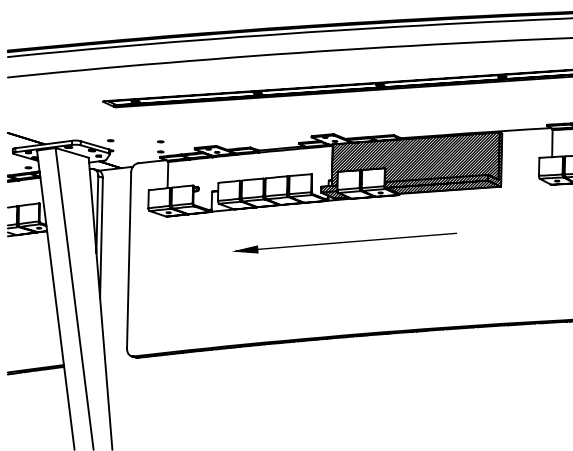

Centered between table segments.

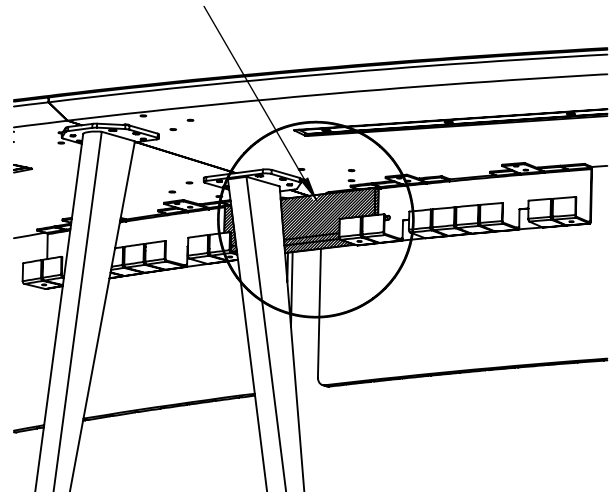

## 7. Install Ports

Place and secure ports and chargers into the designated openings on the tabletop.

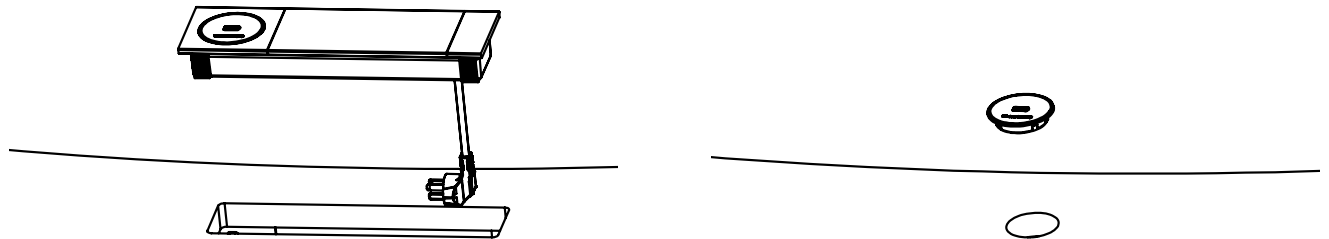

### LIMITED WARRANTY FOR COMMERCIAL VIDEO DISPLAY STANDS AND MOUNTS

Salamander is proud to stand behind our products with industry-leading warranties. Should you ever encounter any problem with your Salamander product, let us know. We are here to make it right. 1.800.535.5659 - 860.761.9500

Full warranty including limitations and warranty claim information may be found at [www.salamanderdesigns.com/commercial/warranty](http://www.salamanderdesigns.com/commercial/warranty)